



Contactor, 380 V 400 V 22 kW, 2 N/O, 2 NC, RDC 24: 24 - 27 V DC, DC operation, Screw terminals

Part no. DILM50-22(RDC24)
Catalog No. 277876
Alternate Catalog No. XTCE050D22TD
EL-Nummer (Norway) 4110339

Delivery program

Product range			Contactors
Application			Contactors for Motors
Subrange			Complete devices up to 170 A
Utilization category			AC-1: Non-inductive or slightly inductive loads, resistance furnaces NAC-3: Normal AC induction motors: starting, switch off during running AC-4: Normal AC induction motors: starting, plugging, reversing, inching
Connection technique			Screw terminals
			
Notes			Also suitable for motors with efficiency class IE3. IE3-ready devices are identified by the logo on their packaging.

Rated operational current

AC-3			
380 V 400 V	I_e	A	50
AC-1			
Conventional free air thermal current, 3 pole, 50 - 60 Hz			
Open			
at 40 °C	$I_{th} = I_e$	A	80
enclosed	I_{th}	A	58
Conventional free air thermal current, 1 pole			
open	I_{th}	A	162
enclosed	I_{th}	A	145

Max. rating for three-phase motors, 50 - 60 Hz

AC-3			
220 V 230 V	P	kW	15.5
380 V 400 V	P	kW	22
660 V 690 V	P	kW	30
AC-4			
220 V 230 V	P	kW	6
380 V 400 V	P	kW	10
660 V 690 V	P	kW	14

Contacts

N/O = Normally open			2 N/O
N/C = Normally closed			2 NC

Instructions

Contacts to EN 50 012.
 integrated suppressor circuit in actuating electronics with mirror contact.

Contact sequence

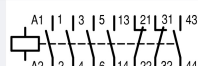

Actuating voltage

RDC 24: 24 - 27 V DC

Voltage AC/DC

DC operation

Technical data

General

Standards			IEC/EN 60947, VDE 0660, UL, CSA
-----------	--	--	---------------------------------

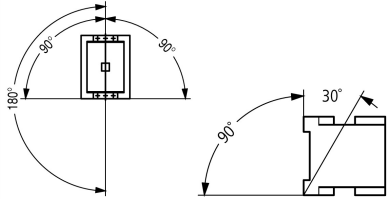
Lifespan, mechanical			
DC operated	Operations	$\times 10^6$	10
Operating frequency, mechanical			
DC operated	Operations/h		5000
Climatic proofing			
			Damp heat, constant, to IEC 60068-2-78 Damp heat, cyclic, to IEC 60068-2-30
Ambient temperature			
Open		°C	-25 - +60
Enclosed		°C	- 25 - 40
Storage		°C	- 40 - 80
Mounting position			
			
Mechanical shock resistance (IEC/EN 60068-2-27)			
Half-sinusoidal shock, 10 ms			
Main contacts			
N/O contact		g	10
Auxiliary contacts			
N/O contact		g	7
N/C contact		g	5
Mechanical shock resistance (IEC/EN 60068-2-27) when tabletop-mounted			
Half-sinusoidal shock, 10 ms			
Main contacts			
N/O contact		g	10
Auxiliary contacts			
N/O contact		g	7
N/C contact		g	5
Degree of Protection			
			IP00
Protection against direct contact when actuated from front (EN 50274)			
			Finger and back-of-hand proof
Weight			
DC operated		kg	1.1
Screw connector terminals			
Terminal capacity main cable			
Solid		mm ²	1 x (0.75 - 16) 2 x (0.75 - 16)
Flexible with ferrule		mm ²	1 x (0.75 - 35) 2 x (0.75 - 25)
Stranded		mm ²	1 x (16 - 50) 2 x (16 - 35)
Solid or stranded		AWG	single 14 - 1, double 14 - 2
Flat conductor	Lamellenzahl x Breite x Dicke	mm	2 x (6 x 9 x 0.8)
Stripping length		mm	14
Terminal screw			M6
Tightening torque		Nm	3.3
Tool			
Pozidriv screwdriver		Size	2
Standard screwdriver		mm	0.8 x 5.5 1 x 6
Terminal capacity control circuit cables			
Solid		mm ²	1 x (0.75 - 2.5) 2 x (0.75 - 2.5)
Flexible with ferrule		mm ²	1 x (0.75 - 2.5) 2 x (0.75 - 2.5)
Solid or stranded		AWG	18 - 14

Stripping length		mm	10
Terminal screw			M3.5
Tightening torque		Nm	1.2
Tool			
Pozidriv screwdriver		Size	2
Standard screwdriver		mm	0.8 x 5.5 1 x 6

Main conducting paths

Rated impulse withstand voltage	U_{imp}	V AC	8000
Overvoltage category/pollution degree			III/3
Rated insulation voltage	U_i	V AC	690
Rated operational voltage	U_e	V AC	690
Safe isolation to EN 61140			
between coil and contacts		V AC	440
between the contacts		V AC	440
Making capacity (p.f. to IEC/EN 60947)			
	Up to 690 V	A	700
Breaking capacity			
220 V 230 V		A	500
380 V 400 V		A	500
500 V		A	500
660 V 690 V		A	320
Short-circuit rating			
Short-circuit protection maximum fuse			
Type "2" coordination			
400 V	gG/gL 500 V	A	80
690 V	gG/gL 690 V	A	63
Type "1" coordination			
400 V	gG/gL 500 V	A	160
690 V	gG/gL 690 V	A	80

AC

AC-1			
Rated operational current			
Conventional free air thermal current, 3 pole, 50 - 60 Hz			
Open			
at 40 °C	$I_{th} = I_e$	A	80
at 50 °C	$I_{th} = I_e$	A	71
at 55 °C	$I_{th} = I_e$	A	68
at 60 °C	$I_{th} = I_e$	A	65
enclosed	I_{th}	A	58
Conventional free air thermal current, 1 pole			
open	I_{th}	A	162
enclosed	I_{th}	A	145
AC-3			
Rated operational current			
Open, 3-pole: 50 – 60 Hz			
Notes			At maximum permissible ambient temperature (open.)
220 V 230 V	I_e	A	50
240 V	I_e	A	50
380 V 400 V	I_e	A	50
415 V	I_e	A	50
440V	I_e	A	50
500 V	I_e	A	50
660 V 690 V	I_e	A	32
380 V 400 V	I_e	A	50

Motor rating	P	kWh	
220 V 230 V	P	kW	15.5
240V	P	kW	17
380 V 400 V	P	kW	22
415 V	P	kW	30
440 V	P	kW	32
500 V	P	kW	36
660 V 690 V	P	kW	30

AC-4

Open, 3-pole: 50 – 60 Hz			
220 V 230 V	I_e	A	21
240 V	I_e	A	21
380 V 400 V	I_e	A	21
415 V	I_e	A	21
440 V	I_e	A	21
500 V	I_e	A	21
660 V 690 V	I_e	A	17

Motor rating	P	kWh	
220 V 230 V	P	kW	6
240 V	P	kW	6.5
380 V 400 V	P	kW	10
415 V	P	kW	11
440 V	P	kW	12
500 V	P	kW	13
660 V 690 V	P	kW	14

DC

Rated operational current, open			
DC-1			
60 V	I_e	A	60
110 V	I_e	A	50
220 V	I_e	A	45

Current heat loss

3 pole, at I_{th} (60°)		W	16.7
Current heat loss at I_e to AC-3/400 V		W	9.9
Impedance per pole		mΩ	1.9

Magnet systems

Voltage tolerance			
DC operated	Pick-up	$x U_c$	0.7 - 1.2
Notes			RDC 24 (U_{min} 24 V DC/ U_{max} 27 V DC) Example: $U_S = 0.7 \times U_{min} - 1.2 \times U_{max} / U_S = 0.7 \times 24V - 1.2 \times 27V$ DC
DC operated	Drop-out	$x U_c$	0.15 - 0.6
Notes			at least smoothed two-phase bridge rectifier or three-phase rectifier
Power consumption of the coil in a cold state and $1.0 \times U_S$			
DC operated	Pick-up	W	24
DC operated	Sealing	W	1
Duty factor		% DF	100
Changeover time at 100 % U_S (recommended value)			
Main contacts			
DC operated		ms	
Closing delay		ms	54
Opening delay		ms	24
Arcing time		ms	10
Lifespan, mechanical; Coil 50/60 Hz		$x 10^6$	Mechanical lifespan at 50 Hz approx. 30% lower than under "Technical data, general"

Electromagnetic compatibility (EMC)

Emitted interference			to EN 60947-1
----------------------	--	--	---------------

Rating data for approved types

Switching capacity			
Maximum motor rating			
Three-phase			
200 V 208 V	HP		15
230 V 240 V	HP		20
460 V 480 V	HP		40
575 V 600 V	HP		50
Single-phase			
115 V 120 V	HP		3
230 V 240 V	HP		10
General use	A		80
Auxiliary contacts			
Pilot Duty			
AC operated			A600
DC operated			P300
General Use			
AC	V		600
AC	A		15
DC	V		250
DC	A		1
Short Circuit Current Rating			
SCCR			
Basic Rating			
SCCR	kA		10
max. Fuse	A		250
max. CB	A		250
480 V High Fault			
SCCR (fuse)	kA		30/100
max. Fuse	A		250/150 Class J
SCCR (CB)	kA		65
max. CB	A		100
600 V High Fault			
SCCR (fuse)	kA		30/100
max. Fuse	A		250/150 Class J
SCCR (CB)	kA		30
max. CB	A		250
Special Purpose Ratings			
Electrical Discharge Lamps (Ballast)			
480V 60Hz 3phase, 277V 60Hz 1phase	A		79
600V 60Hz 3phase, 347V 60Hz 1phase	A		79
Incandescent Lamps (Tungsten)			
480V 60Hz 3phase, 277V 60Hz 1phase	A		74
600V 60Hz 3phase, 347V 60Hz 1phase	A		74
Resistance Air Heating			
480V 60Hz 3phase, 277V 60Hz 1phase	A		79
600V 60Hz 3phase, 347V 60Hz 1phase	A		79
Elevator Control			
200V 60Hz 3phase	HP		10
200V 60Hz 3phase	A		32.2
240V 60Hz 3phase	HP		15
240V 60Hz 3phase	A		42

480V 60Hz 3phase	HP	30
480V 60Hz 3phase	A	40
600V 60Hz 3phase	HP	40
600V 60Hz 3phase	A	41

Design verification as per IEC/EN 61439

Technical data for design verification			
Rated operational current for specified heat dissipation	I_n	A	50
Heat dissipation per pole, current-dependent	P_{vid}	W	3.3
Equipment heat dissipation, current-dependent	P_{vid}	W	9.9
Static heat dissipation, non-current-dependent	P_{vs}	W	1
Heat dissipation capacity	P_{diss}	W	0
Operating ambient temperature min.		°C	-25
Operating ambient temperature max.		°C	60
IEC/EN 61439 design verification			
10.2 Strength of materials and parts			
10.2.2 Corrosion resistance			
			Meets the product standard's requirements.
10.2.3.1 Verification of thermal stability of enclosures			
			Meets the product standard's requirements.
10.2.3.2 Verification of resistance of insulating materials to normal heat			
			Meets the product standard's requirements.
10.2.3.3 Verification of resistance of insulating materials to abnormal heat and fire due to internal electric effects			
			Meets the product standard's requirements.
10.2.4 Resistance to ultra-violet (UV) radiation			
			Meets the product standard's requirements.
10.2.5 Lifting			
			Does not apply, since the entire switchgear needs to be evaluated.
10.2.6 Mechanical impact			
			Does not apply, since the entire switchgear needs to be evaluated.
10.2.7 Inscriptions			
			Meets the product standard's requirements.
10.3 Degree of protection of ASSEMBLIES			
			Does not apply, since the entire switchgear needs to be evaluated.
10.4 Clearances and creepage distances			
			Meets the product standard's requirements.
10.5 Protection against electric shock			
			Does not apply, since the entire switchgear needs to be evaluated.
10.6 Incorporation of switching devices and components			
			Does not apply, since the entire switchgear needs to be evaluated.
10.7 Internal electrical circuits and connections			
			Is the panel builder's responsibility.
10.8 Connections for external conductors			
			Is the panel builder's responsibility.
10.9 Insulation properties			
10.9.2 Power-frequency electric strength			
			Is the panel builder's responsibility.
10.9.3 Impulse withstand voltage			
			Is the panel builder's responsibility.
10.9.4 Testing of enclosures made of insulating material			
			Is the panel builder's responsibility.
10.10 Temperature rise			
			The panel builder is responsible for the temperature rise calculation. Eaton will provide heat dissipation data for the devices.
10.11 Short-circuit rating			
			Is the panel builder's responsibility. The specifications for the switchgear must be observed.
10.12 Electromagnetic compatibility			
			Is the panel builder's responsibility. The specifications for the switchgear must be observed.
10.13 Mechanical function			
			The device meets the requirements, provided the information in the instruction leaflet (IL) is observed.

Technical data ETIM 7.0

Low-voltage industrial components (EG000017) / Power contactor, AC switching (EC000066)			
Electric engineering, automation, process control engineering / Low-voltage switch technology / Contactor (LV) / Power contactor, AC switching (ecl@ss10.0.1-27-37-10-03 [AAB718015])			
Rated control supply voltage U_s at AC 50HZ	V		0 - 0
Rated control supply voltage U_s at AC 60HZ	V		0 - 0
Rated control supply voltage U_s at DC	V		24 - 27
Voltage type for actuating			DC
Rated operation current I_e at AC-1, 400 V	A		80
Rated operation current I_e at AC-3, 400 V	A		50
Rated operation power at AC-3, 400 V	kW		22
Rated operation current I_e at AC-4, 400 V	A		21
Rated operation power at AC-4, 400 V	kW		10
Rated operation power NEMA	kW		29.8

Modular version		No
Number of auxiliary contacts as normally open contact		2
Number of auxiliary contacts as normally closed contact		2
Type of electrical connection of main circuit		Screw connection
Number of normally closed contacts as main contact		0
Number of main contacts as normally open contact		3

Approvals

Product Standards		IEC/EN 60947-4-1; UL 60947-4-1; CSA - C22.2 No. 60947-4-1-14; CE marking
UL File No.		E29096
UL Category Control No.		NLDX
CSA File No.		012528
CSA Class No.		2411-03, 3211-04
North America Certification		UL listed, CSA certified
Specially designed for North America		No

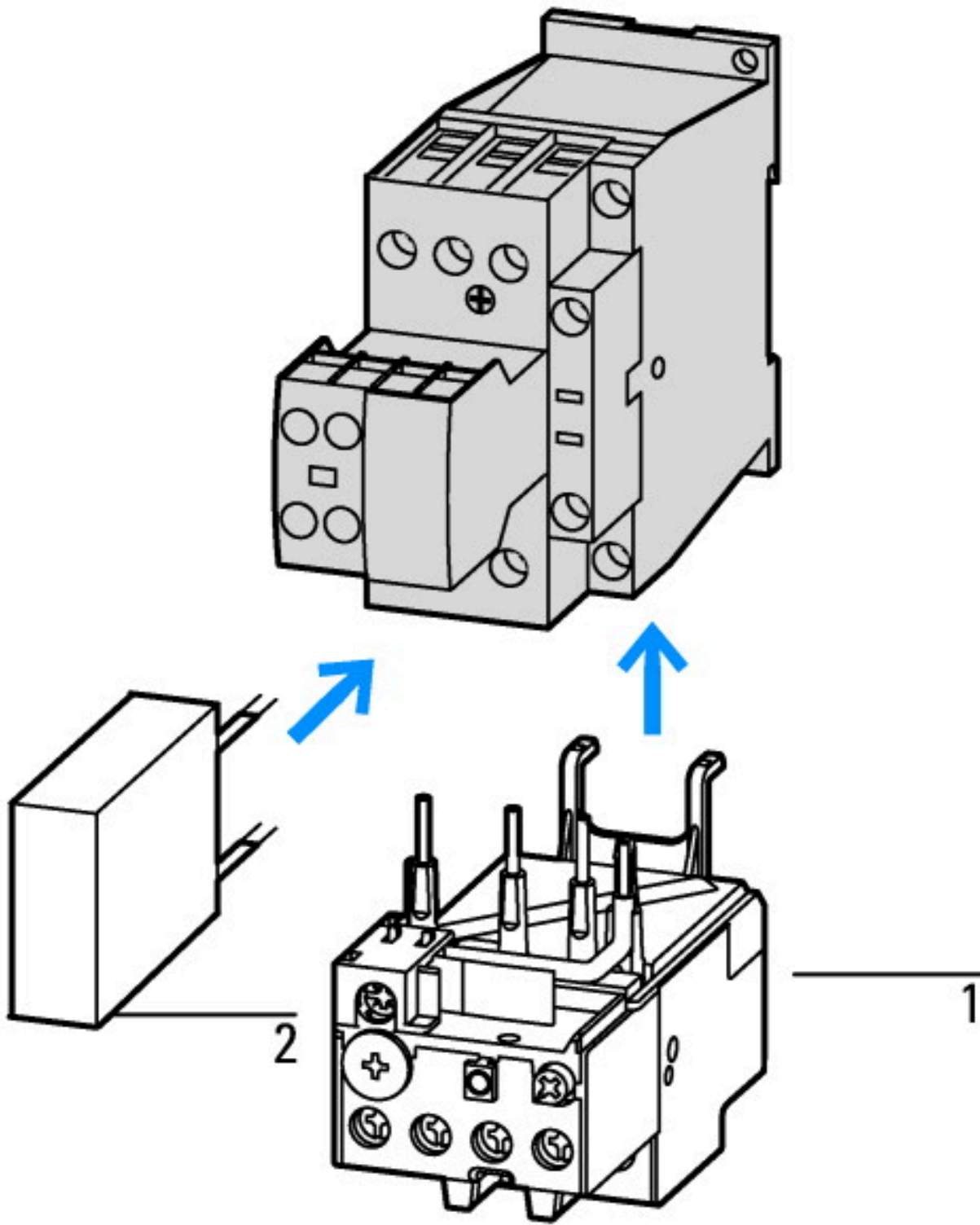

- 1: Overload relay
- 2: Suppressor

DILM1000-XHI(V)11-...

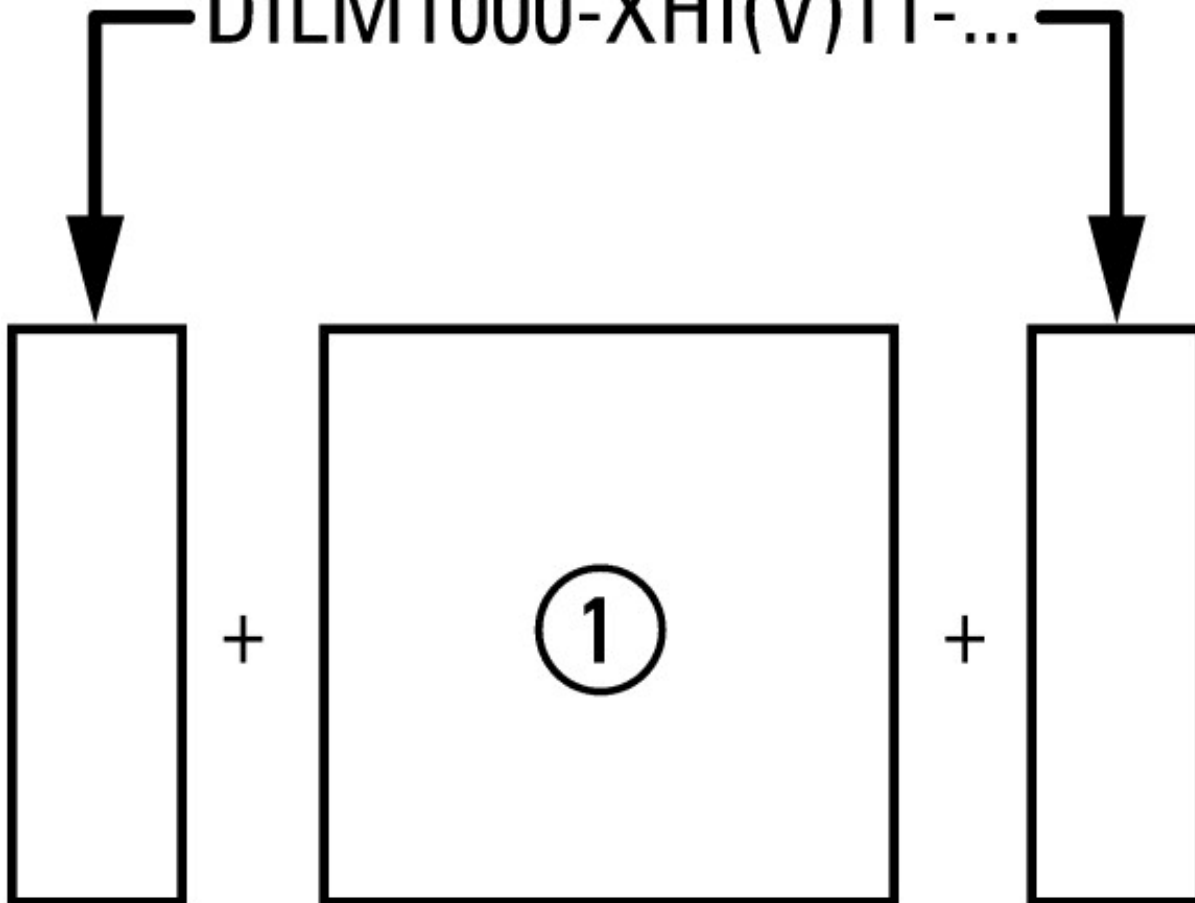

on the side: 2 x DILM1000-XHI(V)11-SI; surface mounting: 1 x DILM150-XHIA11
 on the side: 2 x DILM1000-XHI(V)11-SA; surface mounting: 1 x DILM150-XHI (2 pole)
 on the side: 1 x DILM1000-XHI(V)11-SI; surface mounting: 1 x DILM150-XHIA22
 on the side: 1 x DILM1000-XHI(V)11-SA; surface mounting: 1 x DILM150-XHI (4 pole)

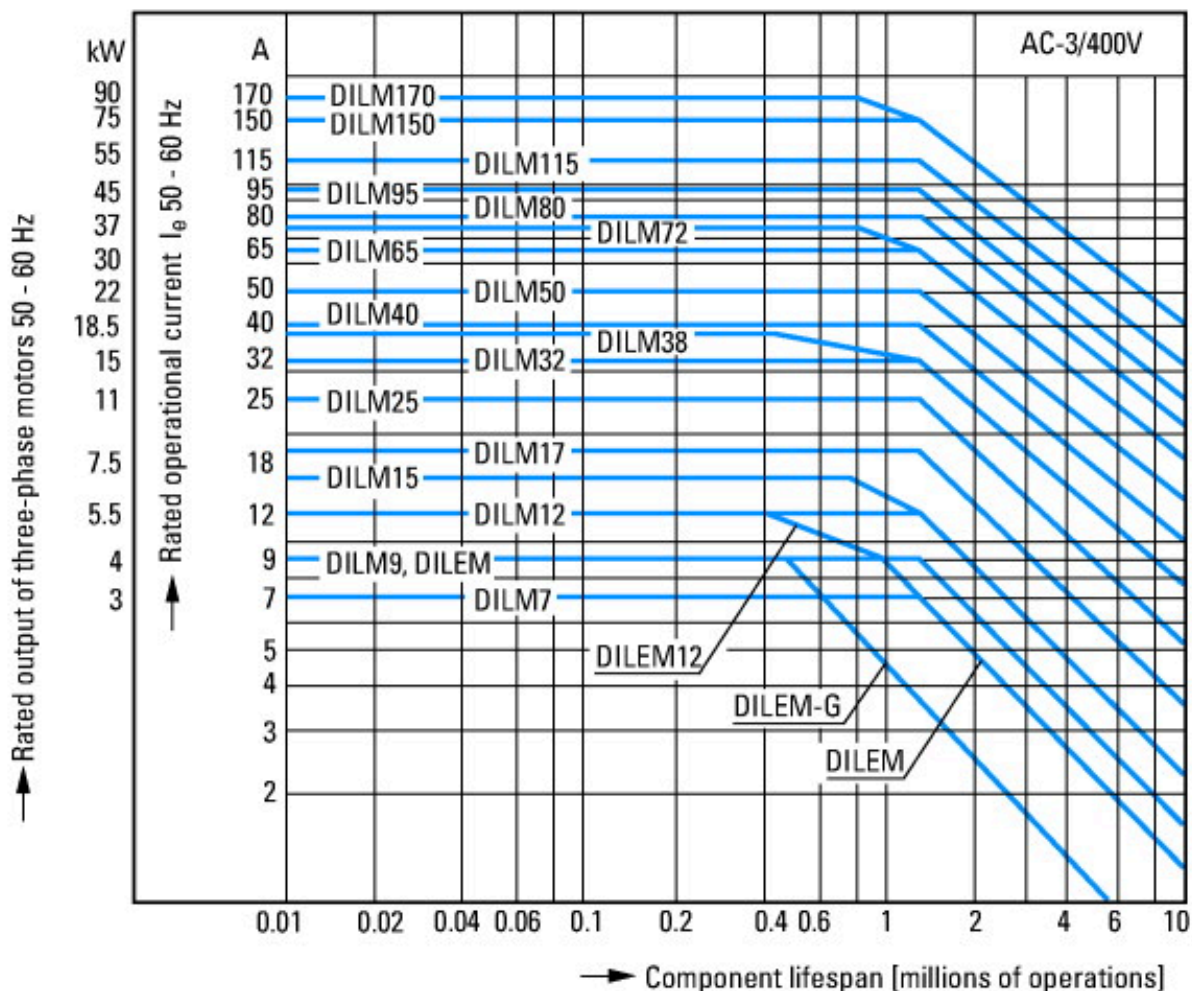

Squirrel-cage motor
 Operating characteristics
 Starting: from rest
 Stopping: after attaining full running speed
 Electrical characteristics
 Make: up to 6 x rated motor current
 Break: up to 1 x rated motor current
 Utilization category
 100 % AC-3
 Typical applications
 Compressors
 Lifts
 Mixers
 Pumps
 Escalators
 Agitators
 Fans
 Conveyor belts
 Centrifuges
 Hinged flaps
 Bucket-elevators
 Air conditioning system
 General drives in manufacturing and processing machines



Extreme switching duty
 Squirrel-cage motor
 Operating characteristics
 Inching, plugging, reversing
 Electrical characteristics
 Make: up to 6 x rated motor current
 Break: up to 6 x rated motor current
 Utilization category
 100 % AC-4
 Typical applications
 Printing presses
 Wire-drawing machines
 Centrifuges
 Special drives for manufacturing and processing machines



Switching conditions for 3 pole, non-motor loads
 Operating characteristics
 Non inductive and slightly inductive loads
 Electrical characteristics
 Switch on: 1 x rated operational current
 Switch off: 1 x rated operational current
 Utilization category
 100 % AC-1
 Typical examples of application
 Electric heat



Dimensions

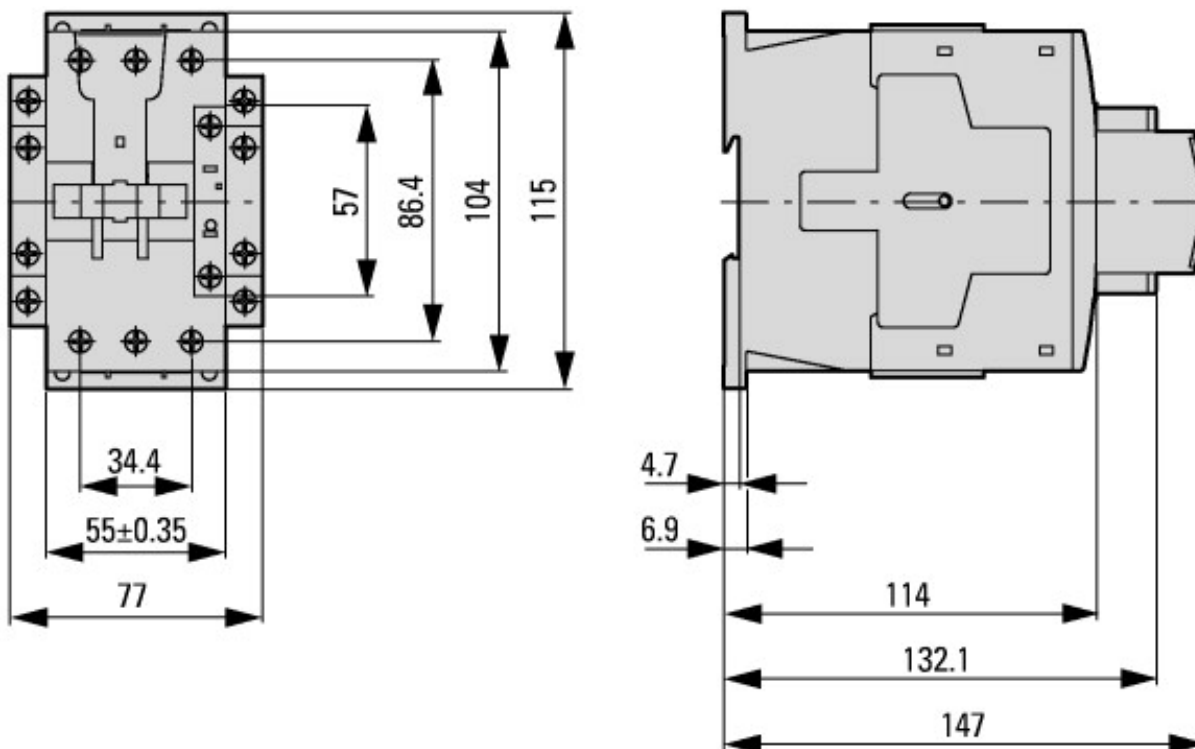

Contactor with auxiliary contact module



Lateral clearance to earthed parts: 6 mm

DILM40...DILM72
DILMC40...DILMC65
DILMF40...DILMF65

Assets (links)

Declaration of CE Conformity

00003252

Instruction Leaflets

IL03407033Z2018_03

Additional product information (links)

IL03407033Z (AWA2100-2247) Contactor DILM, basic unit

IL03407033Z (AWA2100-2247) Contactor DILM, basic unit ftp://ftp.moeller.net/DOCUMENTATION/AWA_INSTRUCTIONS/IL03407033Z2018_03.pdf

MN034004 Rapid Link 5.0 RAMO RASP

MNxx3 <Title> - Deutsch	ftp://ftp.moeller.net/DOCUMENTATION/AWB_MANUALS/MN034004_DE.pdf
Motor starters and "Special Purpose Ratings" for the North American market	http://www.eaton.eu/ecm/groups/public/@pub/@europe/@electrical/documents/content/pct_3258146.pdf
Switchgear of Power Factor Correction Systems	http://www.moeller.net/binary/ver_techpapers/ver934en.pdf
X-Start - Modern Switching Installations Efficiently Fitted and Wired Securely	http://www.moeller.net/binary/ver_techpapers/ver938en.pdf
Mirror Contacts for Highly-Reliable Information Relating to Safety-Related Control Functions	http://www.moeller.net/binary/ver_techpapers/ver944en.pdf
Effect of the Cabel Capacitance of Long Control Cables on the Actuation of Contactors	http://www.moeller.net/binary/ver_techpapers/ver949en.pdf
Switchgear for Luminaires	http://www.moeller.net/binary/ver_techpapers/ver955en.pdf
Standard Compliant and Functionally Safe Engineering Design with Mechanical Auxiliary Contacts	http://www.moeller.net/binary/ver_techpapers/ver956en.pdf
The Interaction of Contactors with PLCs	http://www.moeller.net/binary/ver_techpapers/ver957en.pdf
Busbar Component Adapters for modern Industrial control panels	http://www.moeller.net/binary/ver_techpapers/ver960en.pdf